

Power supply terminal (low profile type)

NQ series

- This is used for supplying power to a PC board.
- Please fit a crimping terminal at the edge of electric wire and tighten with a screw.
- Material: Copper
- Finish: Tin plating over nickel base

■ Part No.

Part No.	Adsorption film	Package	Rated current	Tightening torque
NQ-2	None	Bulk (100pcs/pack)	20A	2kgf-cm (19.6N-cm) or less
NQ-2-T	None	Reel (450pcs/reel)		
NQ-2-T-A	Include	Reel (450pcs/reel)	30A	5kgf-cm (49N-cm) or less
NQ-3	None	Bulk (100pcs/pack)		
NQ-3-T	None	Reel (400pcs/reel)		
NQ-3-T-A	Include	Reel (400pcs/reel)		

※ Please remove the adsorption film after mounting.

■ Recommended metal mask thickness

150 μm to 200 μm

■ Dimension

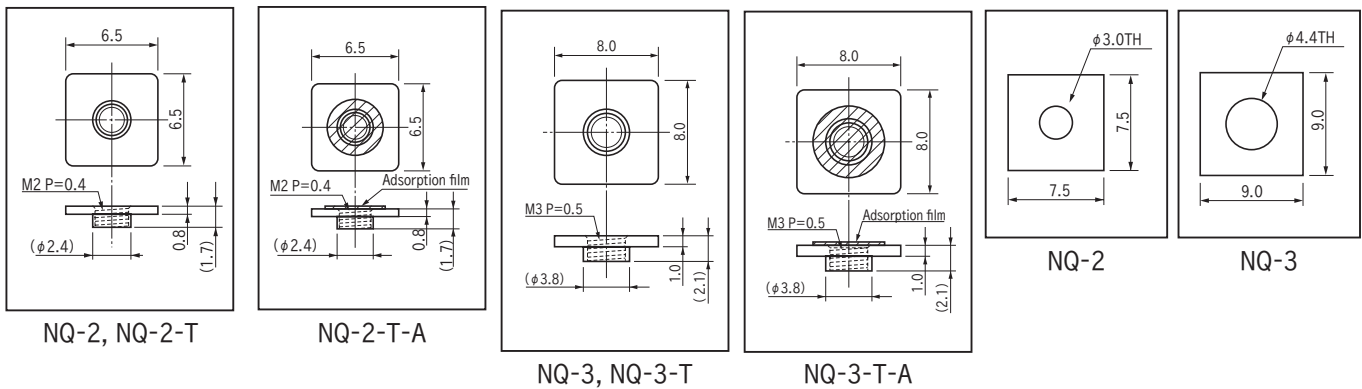

■ Recommend metal mask

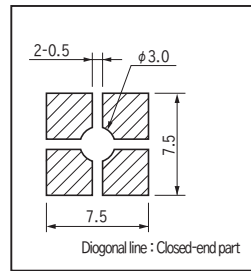

NQ-2

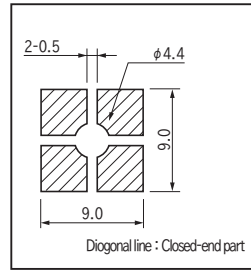

NQ-3

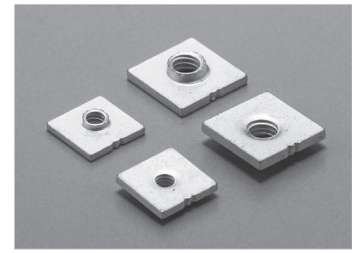

■ Example of usage

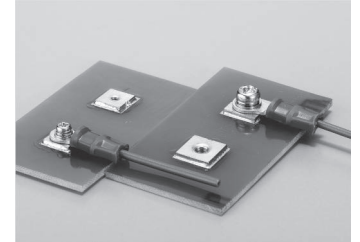

■ Recommended land information

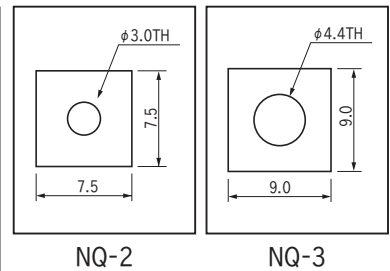

■ NQ-2-T, NQ-2-T-A Dimension

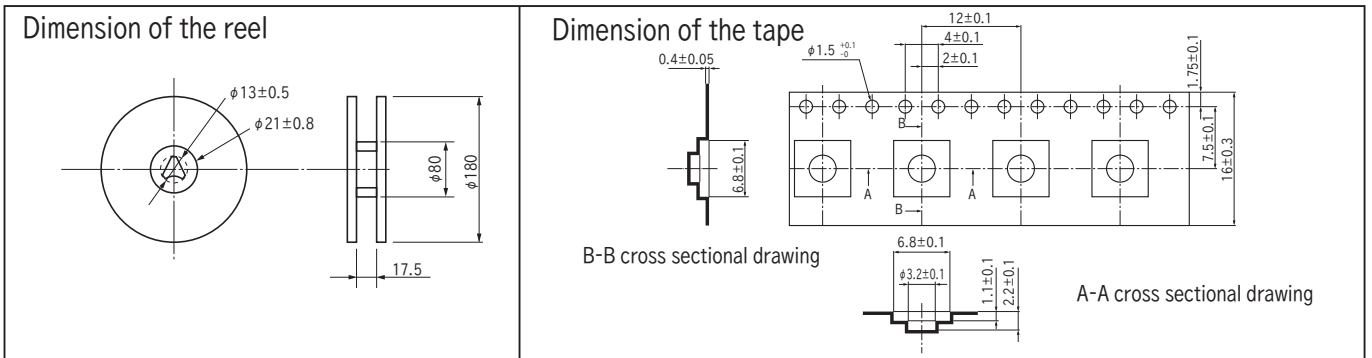

■ NQ-3-T, NQ-3-T-A Dimension

